

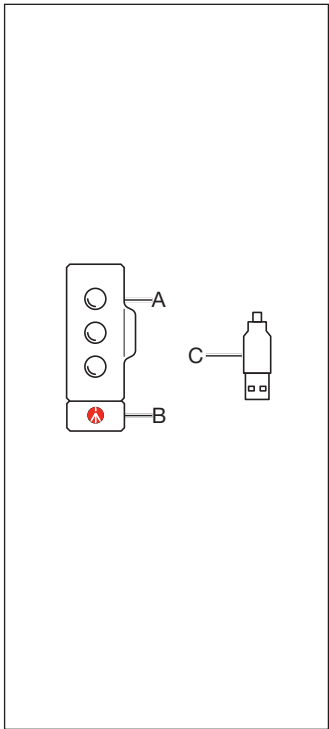

 **KLYP +** 

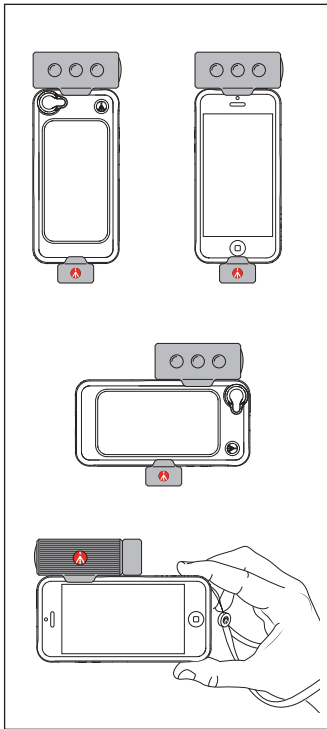





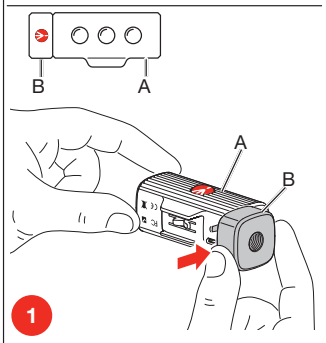
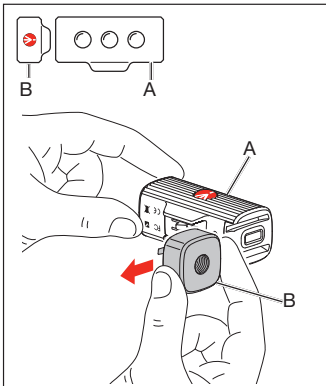

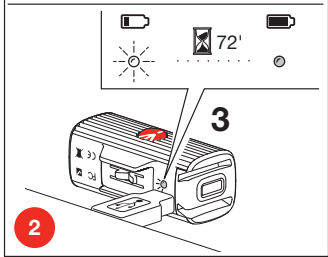
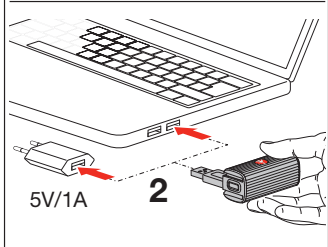
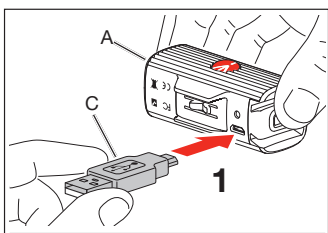

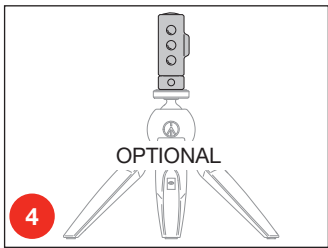
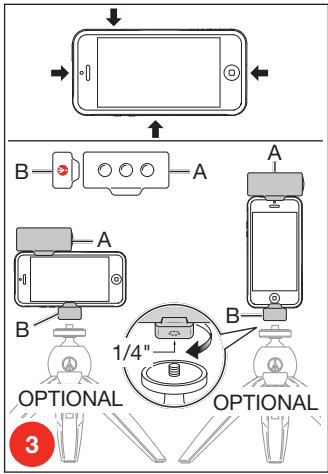

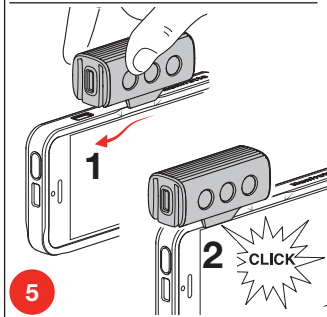
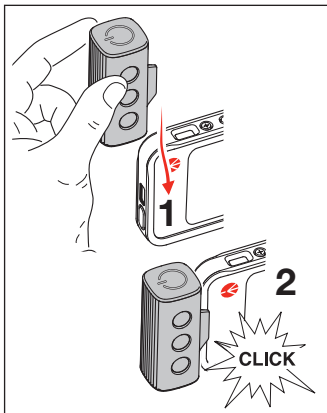



6

7





< 50°C
> -10°C

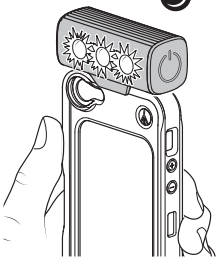

8





The LED light cannot charge and work at the same time.

L'illuminatore a LED non può essere ricaricato quando è acceso.

La diode ne peut pas être en charge et allumée en même temps.

Die LED-Leuchte kann nicht gleichzeitig geladen und betrieben werden.

La lámpara de LEDs no puede recargarse y usarse al mismo tiempo.

このLEDライトは充電と発光を同時に行えません。

LED灯无法同时充电和工作。

LED충전중에는 제품 사용이 불가능 합니다.

Осветительный прибор со светодиодами не может заряжаться и работать в одно и то же время.

The product was tested in accordance with safety standard IEC 62471:2006 "Photobiological Safety of Lamps and Lamp Systems".

Il prodotto è stato testato secondo lo standard di sicurezza IEC 62471:2006 "Photobiological safety of lamps and lamp systems".

Ce produit a été testé conformément à la norme de sécurité CEI 62471:2006, « sécurité photobiologique des lampes et des luminaires ».

Das Produkt wurde nach dem Sicherheitsstandard IEC 62471:2006 "Photobiologische Sicherheit von Lampen und Lampensystemen" geprüft.

El producto fue probado conforme a la norma de seguridad IEC 62471:2006 "Seguridad fotobiológica de lámparas y de los aparatos que utilizan lámparas."

本製品は安全規格IEC 62471:2006 "ランプ及びランプシステムの光生物学的安全性" に沿ってテストされております。

此产品经过测试通过安全标准IEC 62471:2006 "灯具及灯具系统光生物安全"

이 제품은 안전기준 IEC 62471:2006 "램프와 램프장치의 광생물학적 안전성"에 따라 테스트 되었습니다.

Продукт прошел тестирование в соответствии со стандартами IEC 62471:2006 "Светобиологическая безопасность ламп и ламповых систем IEC".



GB

5 years warranty (register your product on www.manfrotto.com to receive the warranty extension)

Thank you for purchasing a Manfrotto product.

Manfrotto products are warranted to be fit for the purpose for which they have been designed, and to be free from defects in materials and workmanship. Visit www.manfrotto.com to have the complete information regarding terms and conditions.

Manfrotto lighting products are covered under one or more of the following U.S. Patents:

6,749,310	7,140,742	7,331,681
6,824,283	7,163,302	7,429,117
6,948,823	7,318,652	7,510,290

Manfrotto lighting products are certified to be in compliance with the following safety directives: CE, FCC, PSE, RoHS, WEEE.





5 anni di garanzia (estensione con registrazione su www.manfrotto.com)

Vi ringraziamo per l'acquisto di un prodotto Manfrotto.

Manfrotto garantisce che i propri prodotti sono idonei allo scopo per il quale sono stati progettati ed esenti da difetti nei materiali e nelle lavorazioni. Visitate il sito www.manfrotto.com per ottenere le informazioni complete relative ai termini e condizioni di garanzia.

I prodotti Manfrotto lighting sono coperti da uno o più dei seguenti brevetti americani:

6,749,310	7,140,742	7,331,681
6,824,283	7,163,302	7,429,117
6,948,823	7,318,652	7,510,290

I prodotti Manfrotto sono certificati rispetto a: CE, FCC, PSE, RoHS, WEEE.





F

5 ans de garantie (enregistrez votre produit sur www.manfrotto.com pour obtenir l'extension de garantie)

Nous vous remercions pour votre achat d'un produit Manfrotto.

Les produits Manfrotto sont garantis d'être adaptés à l'usage pour lequel ils ont été conçus, et d'être exempts de défauts de matériaux et de fabrication. Rendez-vous sur www.manfrotto.com pour plus d'informations concernant les termes et les conditions.

Les équipements d'éclairage Manfrotto sont couverts par un ou plusieurs brevets aux USA :

6,749,310	7,140,742	7,331,681
6,824,283	7,163,302	7,429,117
6,948,823	7,318,652	7,510,290

Les équipements d'éclairage Manfrotto sont certifiés conformes aux directives de sécurité suivantes: CE, FCC, PSE, RoHS, WEEE.





D

5 Jahre Garantie (Registrieren Sie Ihr Produkt auf www.manfrotto.com für die Garantieverlängerung)

Danke, dass Sie sich für ein Manfrotto Produkt entschieden haben.

Manfrotto Produkte unterliegen einer Garantie, die in Abstimmung der Materialien und Einsatzgebiete der Produkte ausgewählt werden.

Alle Garantiebestimmungen finden Sie ausführlich unter www.manfrotto.com

Manfrotto Lighting-Produkte werden durch ein oder mehrere der folgenden US-Patente abgedeckt:

6,749,310	7,140,742	7,331,681
6,824,283	7,163,302	7,429,117
6,948,823	7,318,652	7,510,290

Manfrotto Lighting-Produkte sind hinsichtlich der Einhaltung der folgenden Sicherheitsvorschriften zertifiziert: CE, FCC, PSE, RoHS, WEEE.





E

Garantía de 5 años (al registrar su producto en www.manfrotto.com para la extensión de su garantía)

Gracias por comprar un producto Manfrotto.

Los productos Manfrotto están garantizados para cumplir el propósito para el que han sido diseñados y están libres de defectos en materiales y mano de obra. Visite www.manfrotto.com para obtener una completa información sobre los términos y condiciones.

Los productos de iluminación Manfrotto están protegidos por una o más de las siguientes patentes de los USA:

6,749,310	7,140,742	7,331,681
6,824,283	7,163,302	7,429,117
6,948,823	7,318,652	7,510,290

Los productos de iluminación Manfrotto están certificados conforme a las siguientes normas de seguridad: CE, FCC, PSE, RoHS, WEEE.





J

5年保証 (www.manfrotto.comへの製品登録による延長保証により)
 Manfrotto製品をご購入いただきありがとうございます。

Manfrotto製品は、その製品が設計された使用目的に適合し、材質および仕上がりにおいて瑕疵がないことが保証されています。保証条件に関する詳細情報については、www.manfrotto.com をご覧ください。

マンフロットLEDライト製品は次の米国特許を1つ以上取得しています:

6,749,310	7,140,742	7,331,681
6,824,283	7,163,302	7,429,117
6,948,823	7,318,652	7,510,290

マンフロットLEDライト製品は以下の安全規格に準拠していることが認定されています。
 CE, FCC, PSE, RoHS, WEEE.





5年保修（通过在www.manfrotto.com 注册您购买的产品可以获得延长保修）
 非常感谢您购买曼富图产品。

曼富图产品的质保，确保其产品满足设计要求，避免从材质到生产工艺方面的瑕疵。
 更多更全面的信息请浏览曼富图官方网站
www.manfrotto.com

曼富图照明产品获得有以下其中一个或多个美国专利：

6,749,310	7,140,742	7,331,681
6,824,283	7,163,302	7,429,117
6,948,823	7,318,652	7,510,290

曼富图照明产品通过了多项认证，符合以下安全指引：CE, FCC, PSE, RoHS, WEEE.





KO

품질보증 기간 5년 (품질보증 기간 연장 시,
웹사이트에 제품 등록 www.manfrotto.com)
맨프로토 제품을 구매해주셔서 진심으로 감
사 드립니다.

맨프로토 제품들은 최고의 품질을 약속하
기 위해 워런티를 제공하며 제품이나 기술
에 하자가 있을 경우 무상으로 서비스를 제
공합니다.

홈 페이지 www.manfrotto.com 에 방문하여
자세한 약관을 확인하시기 바랍니다.

맨프로토 조명 제품은 한 개 이상의 U.S. 특허
권을 취득하였습니다:

6,749,310	7,140,742	7,331,681
6,824,283	7,163,302	7,429,117
6,948,823	7,318,652	7,510,290

맨프로토 조명 제품은 다음의 안전 명시를 준
수하는 공인된 제품입니다: CE, FCC, PSE,
RoHS, WEEE.





RU

5 лет гарантии (при регистрации вашего продукта на сайте www.manfrotto.com для получения продления гарантии)

Благодарим вас за покупку продукта Manfrotto.

Гарантия на продукты Manfrotto предоставляется на их использование по назначению, для которого они были созданы, и на отсутствие дефектов материалов и сборки.

Зайдите на сайт www.manfrotto.com для получения полной информации об условиях и положениях.

Продукты Manfrotto lighting входят в один или более патентов в США:

6,749,310	7,140,742	7,331,681
6,824,283	7,163,302	7,429,117
6,948,823	7,318,652	7,510,290

Продукты Manfrotto lighting сертифицированы в соответствии со следующими директивами о безопасности: CE, FCC, PSE, RoHS, WEEE.





KLYP+ System:

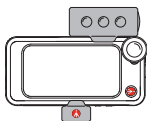
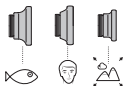

You may be interested in:



PIXI



Compact Tripod



Compact Monopod



Visit www.manfrotto.com

Cod. 105347 - 10/13 Copyright © 2013 Manfrotto Bassano Italy

