

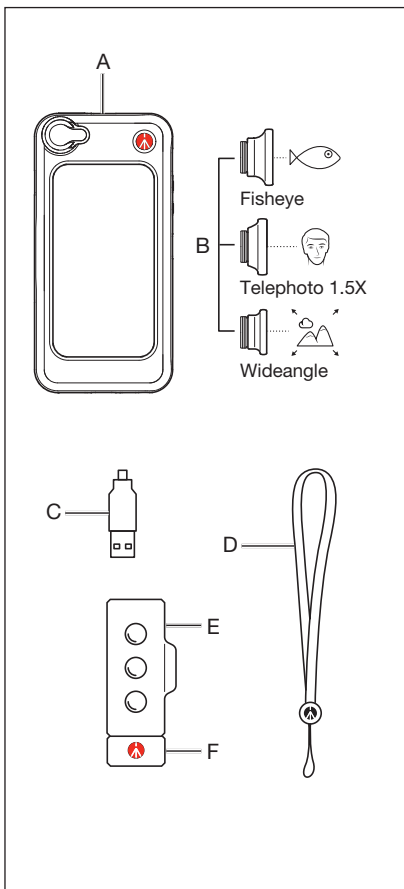

**KLYP +**

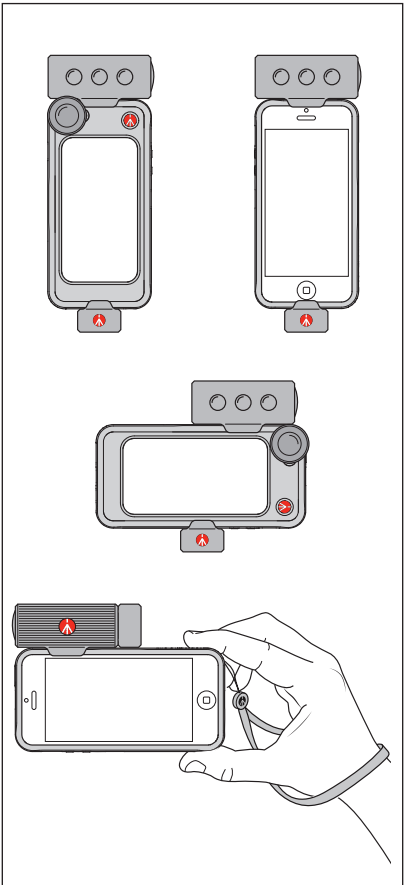





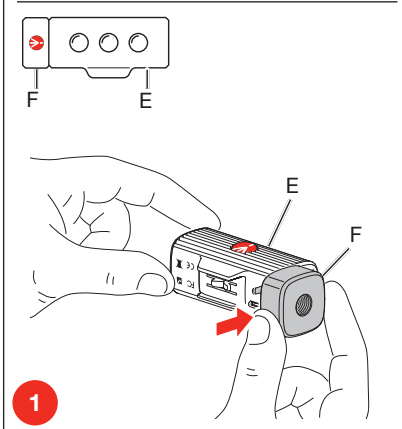
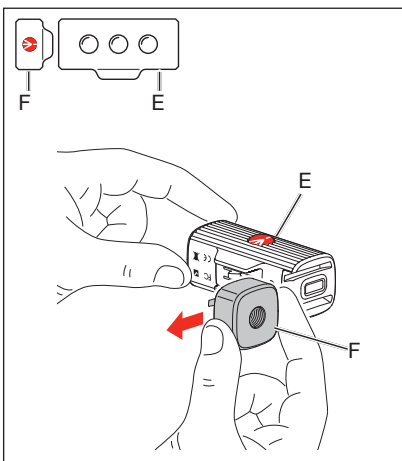

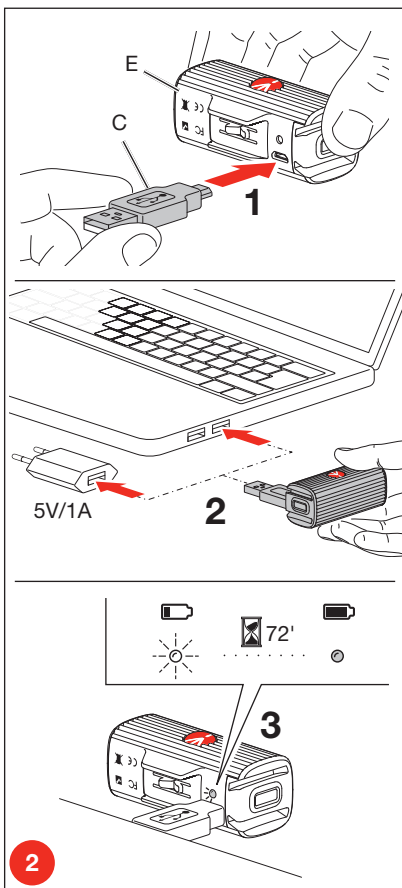

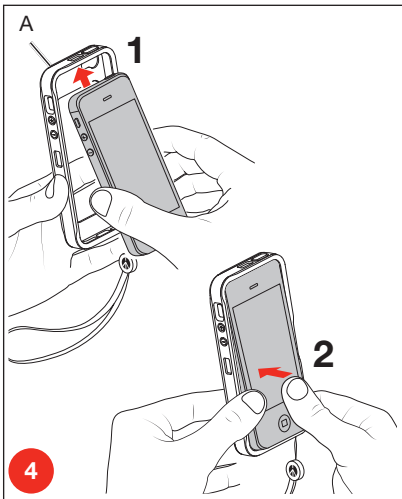
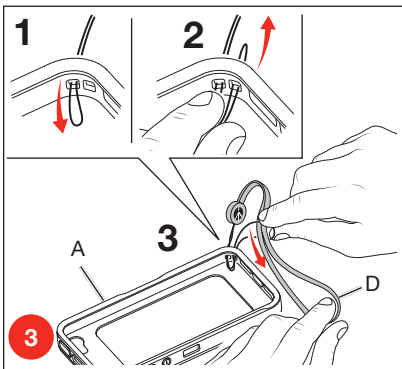

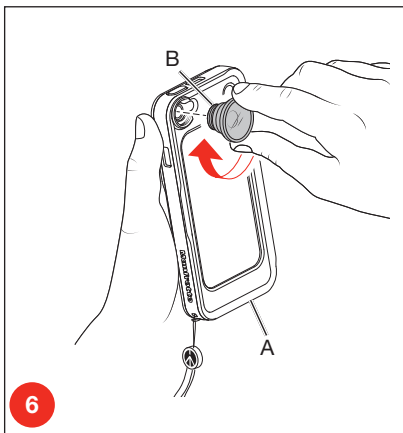
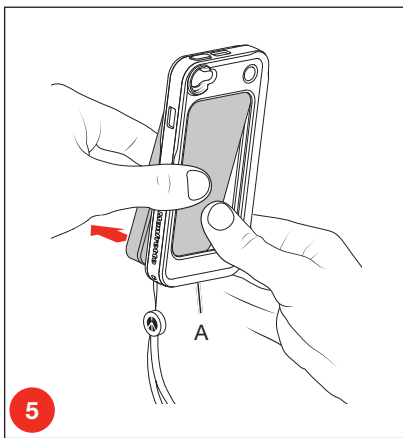

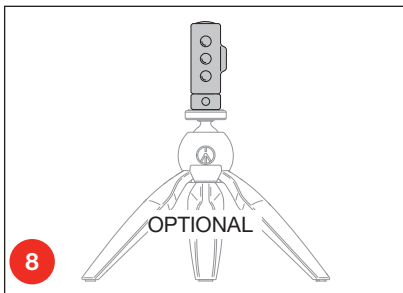
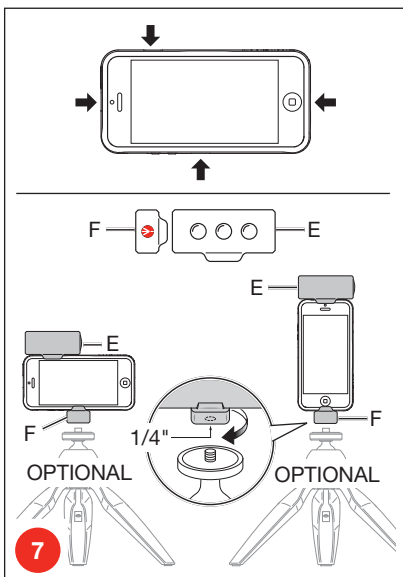



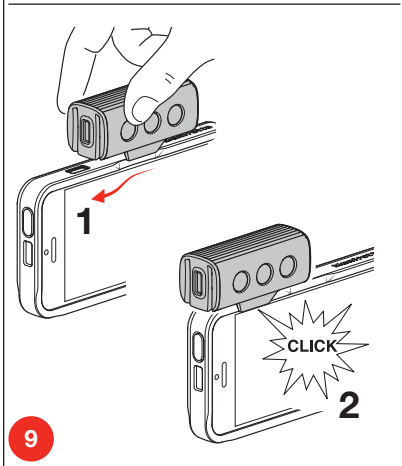
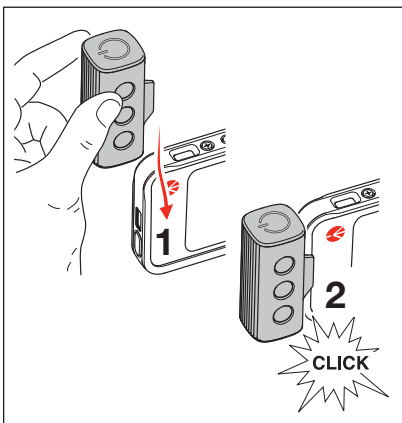

9



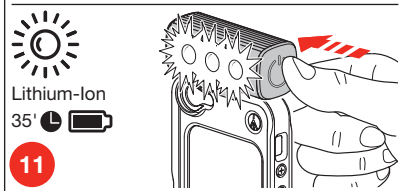
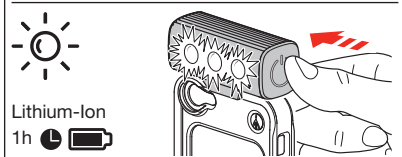
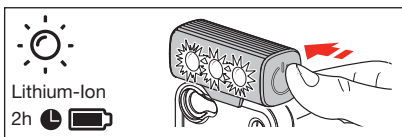
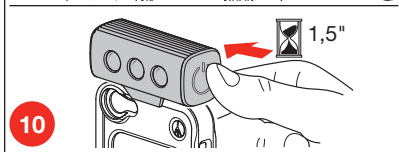
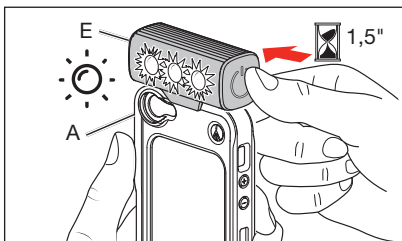



< 50°C

> -10°C



The LED light cannot charge and work at the same time.

L'illuminatore a LED non può essere ricaricato quando è acceso.

La diode ne peut pas être en charge et allumée en même temps.

Die LED-Leuchte kann nicht gleichzeitig geladen und betrieben werden.

La lámpara de LEDs no puede recargarse y usarse al mismo tiempo.

このLEDライトは充電と発光を同時に行えません。  
LED灯无法同时充电和工作。

LED충전중에는 제품 사용이 불가능 합니다.

Осветительный прибор со светодиодами не может заряжаться и работать в одно и то же время.

The product was tested in accordance with safety standard IEC 62471:2006 "Photobiological Safety of Lamps and Lamp Systems".

Il prodotto è stato testato secondo lo standard di sicurezza IEC 62471:2006 "Photobiological safety of lamps and lamp systems".

Ce produit a été testé conformément à la norme de sécurité CEI 62471:2006, « sécurité photobiologique des lampes et des luminaires ».

Das Produkt wurde nach dem Sicherheitsstandard IEC 62471:2006 "Photobiologische Sicherheit von Lampen und Lampensystemen" geprüft.

El producto fue probado conforme a la norma de seguridad IEC 62471:2006 "Seguridad fotobiológica de lámparas y de los aparatos que utilizan lámparas."

本製品は安全規格IEC 62471:2006 "ランプ及びランプシステムの光生物学的安全性" に沿ってテストされています。  
此产品经过测试通过安全标准IEC 62471:2006 "灯具及灯具系统光生物安全"

이 제품은 안전기준 IEC 62471:2006 "램프와 램프장치의 광생물학적 안전성"에 따라 테스트 되었습니다.

Продукт прошел тестирование в соответствии со стандартами IEC 62471:2006 "Светобиологическая безопасность ламп и ламповых систем IEC".

12





GB

*2 years warranty Bumper (register your product on [www.manfrotto.com](http://www.manfrotto.com) to receive the warranty extension)*

*2 years warranty Lenses (register your product on [www.manfrotto.com](http://www.manfrotto.com) to receive the warranty extension)*

*5 years warranty LED+tripod mount (register your product on [www.manfrotto.com](http://www.manfrotto.com) to receive the warranty extension)*

*Thank you for purchasing a Manfrotto product.*

Manfrotto products are warranted to be fit for the purpose for which they have been designed, and to be free from defects in materials and workmanship. Visit [www.manfrotto.com](http://www.manfrotto.com) to have the complete information regarding terms and conditions.

Manfrotto lighting products are covered under one or more of the following U.S. Patents:

6,749,310	7,140,742	7,331,681
6,824,283	7,163,302	7,429,117
6,948,823	7,318,652	7,510,290

Manfrotto lighting products are certified to be in compliance with the following safety directives: CE, FCC, PSE, RoHS, WEEE.





*2 anni di garanzia Bumper (estensione con registrazione su [www.manfrotto.com](http://www.manfrotto.com))*  
*2 ans de garantie sur les objectifs (enregistrez votre produit sur [www.manfrotto.com](http://www.manfrotto.com) pour bénéficier de l'extension de garantie)*  
*5 anni di garanzia LED+tripod mount (estensione con registrazione su [www.manfrotto.com](http://www.manfrotto.com))*  
*Vi ringraziamo per l'acquisto di un prodotto Manfrotto.*

Manfrotto garantisce che i propri prodotti sono idonei allo scopo per il quale sono stati progettati ed esenti da difetti nei materiali e nelle lavorazioni. Visitate il sito [www.manfrotto.com](http://www.manfrotto.com) per ottenere le informazioni complete relative ai termini e condizioni di garanzia.

I prodotti Manfrotto lighting sono coperti da uno o più dei seguenti brevetti americani:

6,749,310	7,140,742	7,331,681
6,824,283	7,163,302	7,429,117
6,948,823	7,318,652	7,510,290

I prodotti Manfrotto sono certificati rispetto a: CE, FCC, PSE, RoHS, WEEE.





## F

*2 ans de garantie sur l'anti-chocs (enregistrez votre produit sur [www.manfrotto.com](http://www.manfrotto.com) pour bénéficier de l'extension de garantie)*

*2 ans de garantie sur les objectifs (enregistrez votre produit sur [www.manfrotto.com](http://www.manfrotto.com) pour bénéficier de l'extension de garantie)*

*5 ans de garantie sur l'ensemble diode + trépied (enregistrez votre produit sur [www.manfrotto.com](http://www.manfrotto.com) pour bénéficier de l'extension de garantie)*

*Nous vous remercions pour votre achat d'un produit Manfrotto.*

Les produits Manfrotto sont garantis d'être adaptés à l'usage pour lequel ils ont été conçus, et d'être exempts de défauts de matériaux et de fabrication. Rendez-vous sur [www.manfrotto.com](http://www.manfrotto.com) pour plus d'informations concernant les termes et les conditions.

Les équipements d'éclairage Manfrotto sont couverts par un ou plusieurs brevets aux USA :

6,749,310	7,140,742	7,331,681
6,824,283	7,163,302	7,429,117
6,948,823	7,318,652	7,510,290

Les équipements d'éclairage Manfrotto sont certifiés conformes aux directives de sécurité suivantes: CE, FCC, PSE, RoHS, WEEE.





## D

*2 Jahre Garantie auf den Stoßdämpfer  
(bitte registrieren Sie Ihr Produkt unter  
[www.manfrotto.com](http://www.manfrotto.com), um von der Erweiterung  
der Garantie zu profitieren)*

*2 Jahre Garantie auf die Linsen (bitte registrie-  
ren Sie Ihr Produkt unter [www.manfrotto.com](http://www.manfrotto.com),  
um von der Erweiterung der Garantie zu  
profitieren)*

*5 Jahre Garantie auf LED-Leuchten und Stati-  
vadapter (bitte registrieren Sie Ihr Produkt unter  
[www.manfrotto.com](http://www.manfrotto.com), um von der Erweiterung  
der Garantie zu profitieren)*

*Danke, dass Sie sich für ein Manfrotto Produkt  
entschieden haben.*

Manfrotto Produkte unterliegen einer Garantie, die  
in Abstimmung der Materialien und Einsatzgebiete  
der Produkte ausgewählt werden.

Alle Garantiebestimmungen finden Sie ausführlich  
unter [www.manfrotto.com](http://www.manfrotto.com)

Manfrotto Lighting-Produkte werden durch ein oder  
mehrere der folgenden US-Patente abgedeckt:

6,749,310	7,140,742	7,331,681
6,824,283	7,163,302	7,429,117
6,948,823	7,318,652	7,510,290

Manfrotto Lighting-Produkte sind hinsichtlich der  
Einhaltung der folgenden Sicherheitsvorschriften  
zertifiziert: CE, FCC, PSE, RoHS, WEEE.



**E**

*2 años de garantía en el parachoques (registre su producto en [www.manfrotto.com](http://www.manfrotto.com) para recibir la extensión de su garantía)*

*2 años de garantía en lentes (registre su producto en [www.manfrotto.com](http://www.manfrotto.com) para recibir la extensión de su garantía)*

*5 años de garantía en LEDs + montura del trípode (registre su producto en [www.manfrotto.com](http://www.manfrotto.com) para recibir la extensión de su garantía)*

*Gracias por comprar un producto Manfrotto.*

Los productos Manfrotto están garantizados para cumplir el propósito para el que han sido diseñados y están libres de defectos en materiales y mano de obra.

Visite [www.manfrotto.com](http://www.manfrotto.com) para obtener una completa información sobre los términos y condiciones.

Los productos de iluminación Manfrotto están protegidos por una o más de las siguientes patentes de los USA:

6,749,310	7,140,742	7,331,681
6,824,283	7,163,302	7,429,117
6,948,823	7,318,652	7,510,290

Los productos de iluminación Manfrotto están certificados conforme a las siguientes normas de seguridad: CE, FCC, PSE, RoHS, WEEE.







**J**

2年保証:バンパー(\*この延長保証を受けるには [www.manfrotto.com](http://www.manfrotto.com) にてお持ちの商品の登録を行って下さい)

2年保証:レンズ(\*この延長保証を受けるには [www.manfrotto.com](http://www.manfrotto.com) にてお持ちの商品の登録を行って下さい)

5年保証:LED + 三脚取付けマウント(\*この延長保証を受けるには[www.manfrotto.com](http://www.manfrotto.com) にてお持ちの商品登録を行って下さい)

Manfrotto製品をご購入いただきありがとうございます。

Manfrotto製品は、その製品が設計された使用目的に適合し、材質および仕上がりにおいて瑕疵がないことが保証されています。保証条件に関する詳細情報については、[www.manfrotto.com](http://www.manfrotto.com) をご覧ください。

マンフロットLEDライト製品は次の米国特許を1つ以上取得しています:

6,749,310	7,140,742	7,331,681
6,824,283	7,163,302	7,429,117
6,948,823	7,318,652	7,510,290

マンフロットLEDライト製品は以下の安全規格に準拠していることが認定されています。

CE, FCC, PSE, RoHS, WEEE.





**CN**

手机壳2年保修(请在[www.manfrotto.com](http://www.manfrotto.com)网站上注册您的产品从而获得延长保修)

镜头2年保修 (请在[www.manfrotto.com](http://www.manfrotto.com)网站上注册您的产品从而获得延长保修)

LED和脚架接环5年保修 (请在[www.manfrotto.com](http://www.manfrotto.com)网站上注册您的产品从而获得延长保修)

非常感谢您购买曼富图产品。

曼富图产品的质保, 确保其产品满足设计要求, 避免从材质到生产工艺方面的瑕疵。

更多更全面的信息请浏览曼富图官方网站

[www.manfrotto.com](http://www.manfrotto.com)

曼富图照明产品获得有以下其中一个或多个美国专利:

6,749,310    7,140,742    7,331,681

6,824,283    7,163,302    7,429,117

6,948,823    7,318,652    7,510,290

曼富图照明产品通过了多项认证, 符合以下安全指引: CE, FCC, PSE, RoHS, WEEE.

**KO**

BUMPER; 품질 보증 기간 2년([www.manfrotto.com](http://www.manfrotto.com) 에서 제품 등록을 하시면 품질 보증 기간을 연장 하실 수 있습니다)

렌즈; 품질 보증 기간 2년([www.manfrotto.com](http://www.manfrotto.com) 에서 제품 등록을 하시면 품질 보증 기간을 연장 하실 수 있습니다)

LED+트라이포드 마운트; 품질 보증 기간 5년

([www.manfrotto.com](http://www.manfrotto.com) 에서 제품 등록을 하시면 품질 보증 기간을 연장 하실 수 있습니다)

만프로토 제품을 구매해주셔서 진심으로 감사 드립니다.

만프로토 제품들은 최고의 품질을 약속하기 위해 워렌티를 제공하며 제품이나 기술에 하자가 있을 경우 무상으로 서비스를 제공합니다.

홈 페이지 [www.manfrotto.com](http://www.manfrotto.com) 에 방문하여 자세한 약관을 확인하시기 바랍니다.

만프로토 조명 제품은 한 개 이상의 U.S. 특허권을 취득하였습니다:

6,749,310    7,140,742    7,331,681

6,824,283    7,163,302    7,429,117

6,948,823    7,318,652    7,510,290

만프로토 조명 제품은 다음의 안전 명시를 준수하는 공인된 제품입니다: CE, FCC, PSE, RoHS, WEEE.





RU

*2 года гарантии на бампер (зарегистрируйте ваш продукт на [www.manfrotto.com](http://www.manfrotto.com) для получения продления гарантии)*

*2 года гарантии на объектив (зарегистрируйте ваш продукт на [www.manfrotto.com](http://www.manfrotto.com) для получения продления гарантии)*

*5 лет гарантии на светодиоды + крепление штатива (зарегистрируйте ваш продукт на [www.manfrotto.com](http://www.manfrotto.com) для получения продления гарантии)*

*Благодарим вас за покупку продукта Manfrotto.*

Гарантия на продукты Manfrotto предоставляется на их использование по назначению, для которого они были созданы, и на отсутствие дефектов материалов и сборки.

Зайдите на сайт [www.manfrotto.com](http://www.manfrotto.com) для получения полной информации об условиях и положениях.

Продукты Manfrotto lighting входят в один или более патентов в США:

6,749,310	7,140,742	7,331,681
6,824,283	7,163,302	7,429,117
6,948,823	7,318,652	7,510,290

Продукты Manfrotto lighting сертифицированы в соответствии со следующими директивами о безопасности: CE, FCC, PSE, RoHS, WEEE.





You may be interested in:



PIXI

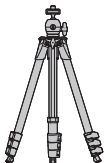

Compact Tripod



Compact Monopod



Visit [www.manfrotto.com](http://www.manfrotto.com)

Cod. 105369 - 10/13

Copyright © 2013 Manfrotto Bassano Italy

