

2005-09-30

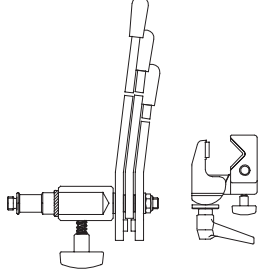
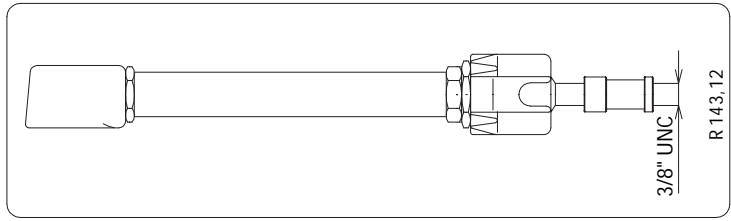
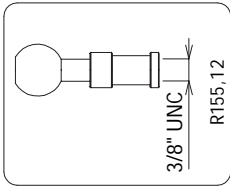
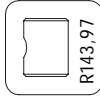
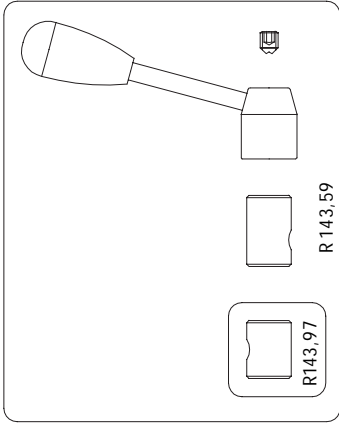
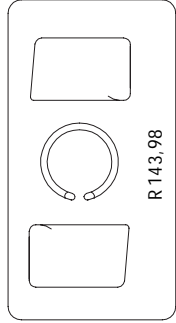
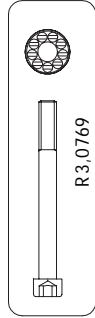
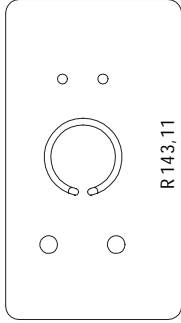
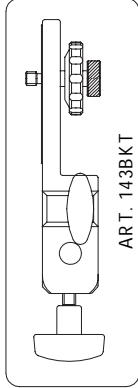
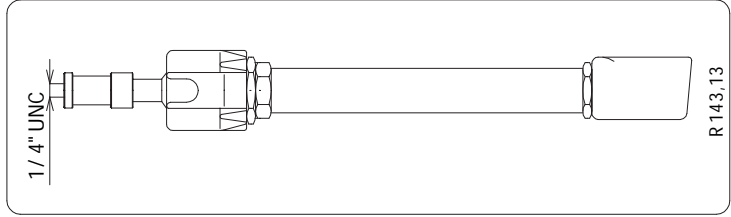
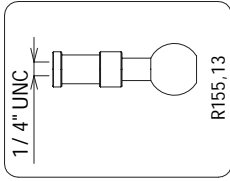
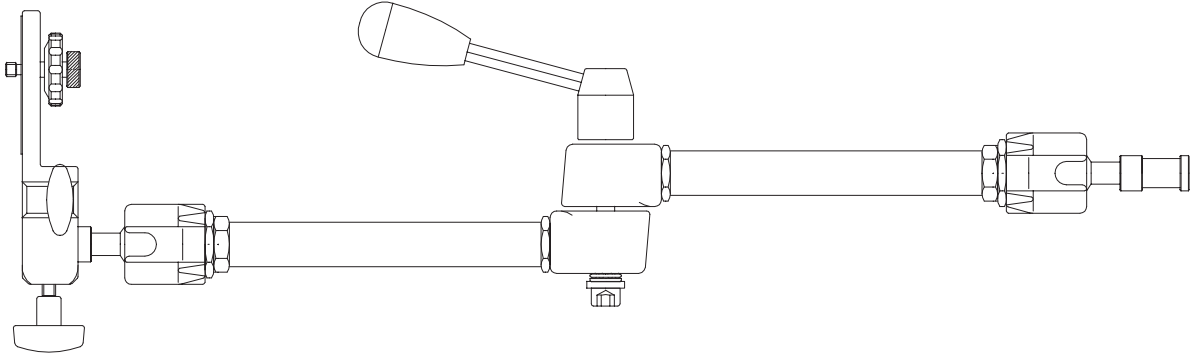

FOR BACKLITE SPARE LIST SEE DRAWING: ART. 003

FOR SUPER CLAMP SPARE LIST SEE DRAWING: ART. 035